

SLAT

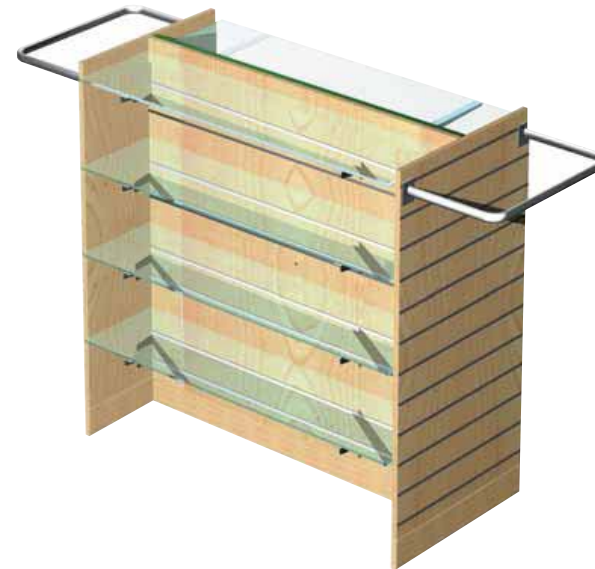

INDEX

Esempi di combinazioni	pag. 394	combinations/Zusammenstellung/combinaisons/примеры
Finiture	pag. 396	finishes/Ausführungen/finitions/отделка
Accessori	pag. 398	accessories/Zubehör/accessoires/аксессуары



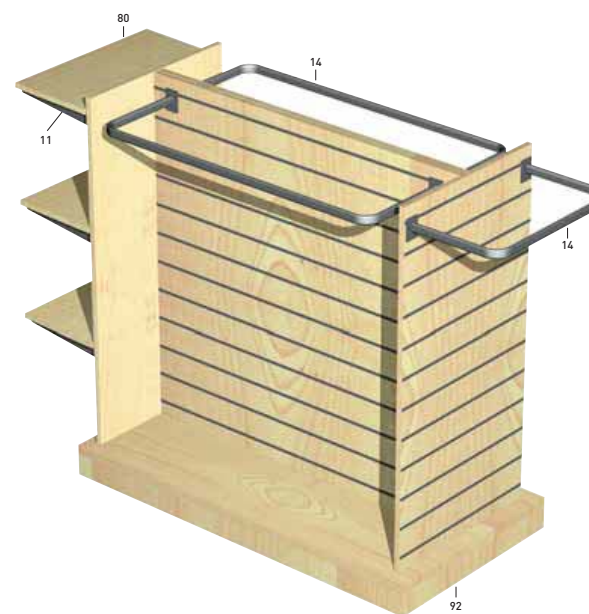
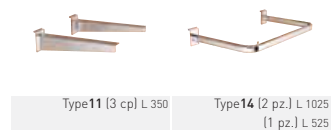
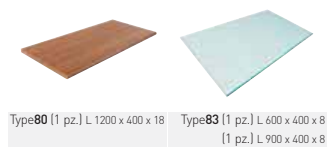
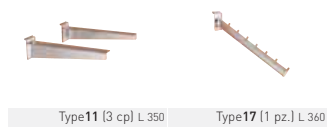
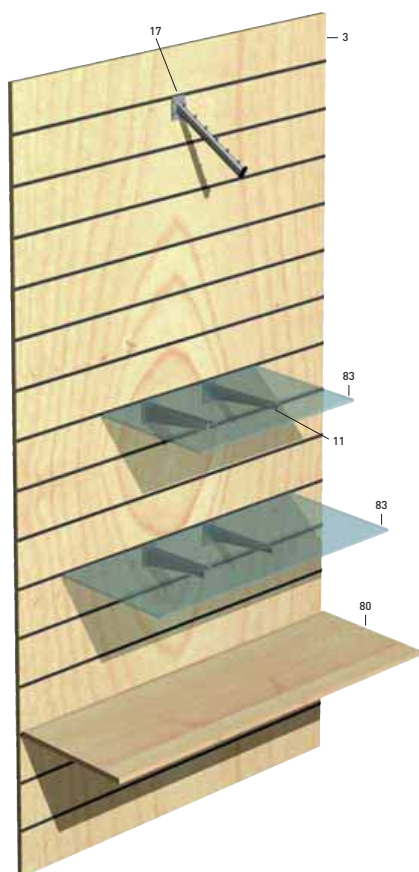

Finiture legno
Wood finishes
Holzausführungen
Finitions bois
Отделка дерева

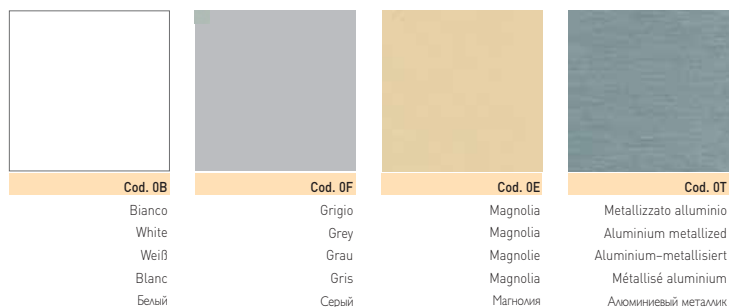
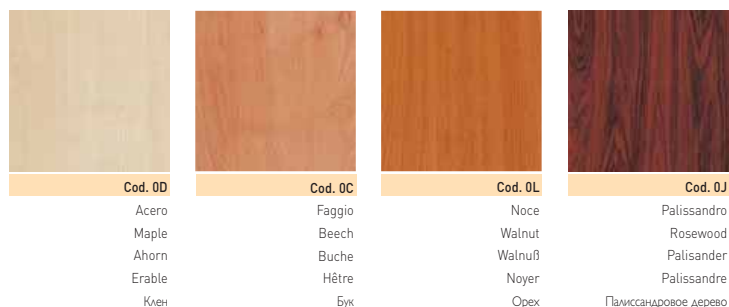

Finiture profili plastica
Plastic profiles finishes
Profils aus Plastik Ausführungen
Profils en plastique finitions
Отделка пластмассовых профилей

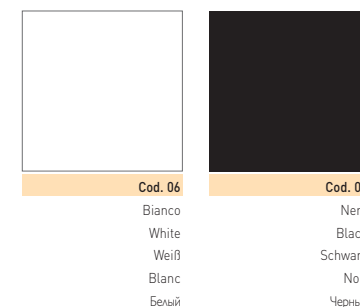

Finiture cristallo
Crystal finishes
Glasausführungen
Finitions cristal
Отделка стекла

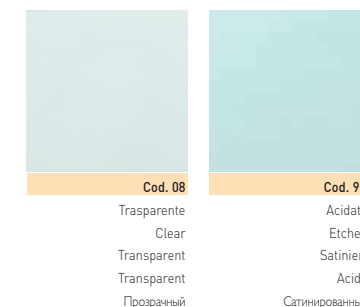



Type 1

	Dim. (mm)	Cod.
Pannello in MDF.	L 1200 x 2400 x 19 P 100	SL0101--0000
MDF panel.		
MDF Paneel.		
Panneau en MDF.		
Панель MDF.		



Type 2

	Dim. (mm)	Cod.
Pannello in MDF.	L 2400 x 1200 x 19 P 100	SL0201--0000
MDF panel.		
MDF Paneel.		
Panneau en MDF.		
Панель MDF.		



Type 2 terminale

	Dim. (mm)	Cod.
Pannello in MDF terminale.	L 2400 x 1200 x 19 P 100	SL0201--00T0
MDF panel with half end slat.		
MDF Paneel mit Halbendlamelle.		
Panneau en MDF avec demi rainure terminale.		
Панель MDF Терминальная.		



Type 3

	Dim. (mm)	Cod.
Pannello in MDF.	L 1200 x 2400 x 19 P 150	SL0301--0000
MDF panel.		
MDF Paneel.		
Panneau en MDF.		
Панель MDF.		



Type 4

	Dim. (mm)	Cod.
Pannello in MDF.	L 2400 x 1200 x 19 P 150	SL0401--0000
MDF panel.		
MDF Paneel.		
Panneau en MDF.		
Панель MDF.		



Type 4 terminale

	Dim. (mm)	Cod.
Pannello in MDF terminale.	L 2400 x 1200 x 19 P 150	SL0401--00T0
MDF panel with half end slat.		
MDF Paneel mit Halbendlamelle.		
Panneau en MDF avec demi rainure terminale.		
Панель MDF Терминальная.		



Type 5

	Dim. (mm)	Cod.
Profilo a "T" in alluminio.	L 1200 L 2400	SL0501--0000 SL0502--0000
Aluminium "T" profile.		
"T" Profil aus Aluminium.		
Profil à "T" en aluminium.		
"T"-образный алюминиевый профиль.		



Type 6

	Dim. (mm)	Cod.
Profilo a "T" in plastica.	L 1200 L 2400	SL0601--0000 SL0602--0000
Plastic "T" profile.		
"T" Profil aus Plastik.		
Profil à "T" en plastique.		
"T"-образный пластмассовый профиль.		

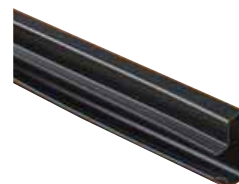

Type 7

	Dim. (mm)	Cod.
Profilo a "L" in plastica.	L 1200 L 2400	SL0701--0000 SL0702--0000
Plastic "L" profile.		
"L" Profil aus Plastik.		
Profil à "L" en plastique.		
"L"-образный пластмассовый профиль.		



Type 8

Coppia mensole per ripiani.
Pair of shelf brackets.
Trägerpaar für Fächer.
Couple supports pour étagères.
Пара полкодержателей.

Dim. (mm)	Cod.
L 250	SL0801--0000
L 300	SL0802--0000



Type 13

Separatore per ripiani.
Sheet splitter.
Trennung für Fächer.
Séparation pour étagères.
Разделитель для полки.

Dim. (mm)	Cod.
L 270	SL1301--0000



Type 9

Ventosa per ripiani in cristallo.
Sucker for crystal shelves.
Sauger für Glasfächer.
Ventouse pour étagère en cristal.
Присоска для стеклянной полки.

Dim. (mm)	Cod.
Ø 23	SL0901--0000



Type 14

Barra appenderia staccata.
Face-out hanging bar.
Hängestange.
Barre d'accrochage décalée.
Вешало.

Dim. (mm)	Cod.
L 525	SL1401--0000
L1025	SL1402--0000



Type 10

Supporto per type 8.
Support for type 8.
Träger für Typ 8.
Support pour type 8.
Держатель вывески для типа 8.

Dim. (mm)	Cod.
L 30 x 15	SL1001--0000



Type 15

Barra appenderia aderente.
Adherent hanging bar.
Gerade Hängestange.
Barre d'accrochage.
Вешало.

Dim. (mm)	Cod.
L 525	SL1501--0000



Type 11

Coppia mensole in lamiera per ripiano.
Pair of sheet shelf brackets.
Trägerpaar aus Blech für Fach.
Couple supports en tôle pour étagère.
Пара металлических полкодержателей.

Dim. (mm)	Cod.
L 200	SL1101--0000
L 250	SL1102--0000
L 300	SL1103--0000
L 350	SL1104--0000



Type 16

Barra diritta.
Straight arm.
Gerader Abhängearm.
Barre droite.
Прямой кронштейн.

Dim. (mm)	Cod.
L 300	SL1601--0000



Type 12

Coppia mensole inclinate in lamiera per ripiano.
Pair of slanted sheet shelf brackets.
Schräges Trägerpaar aus Blech für Fach.
Couple supports inclinés en tôle pour étagère.
Пара металлических наклонных полкодержателей.

Dim. (mm)	Cod.
L 300	SL1201--0000



Type 17

Barra inclinata.
Sloping arm.
Schräger Abhängearm.
Barre inclinée.
Наклонный кронштейн.

Dim. (mm)	Cod.
L 360	SL1701--0000



Type 18

Barra inclinata con ganci.
Hook sloping arm.
Schräger Abhängearm mit Haken.
Barre inclinée avec crochets.
Наклонный кронштейн с крючками.

Dim. (mm)	Cod.
L 360	SL1801--0000



Type 23

Barretta a tre gradini.
3-step hook.
3-Stufen Abhängearm.
Tige à trois marches.
3-х-ступенчатый крючок.

Dim. (mm)	Cod.
L 300	SL2301--0000



Type 19

Barretta.
Hook.
Abhängearm.
Tige.
Кронштейн.

Dim. (mm)	Cod.
L 100	SL1901--0000
L 150	SL1902--0000
L 200	SL1903--0000
L 250	SL1904--0000
Ø 6	



Type 24

Espositore multiplo.
Clutch bag/purse display.
Vielfacher Aufsteller.
Élément expositif multiple.
Экспозитор.

Dim. (mm)	Cod.
L 400	SL2401--0000



Type 20

Barretta.
Hook.
Abhängearm.
Tige.
Кронштейн.

Dim. (mm)	Cod.
L 300	SL2001--0000
Ø 8	



Type 25

Espositore frontale.
Frontal display.
Frontaufsteller.
Tige frontale.
Фронтальный экспозитор.

Dim. (mm)	Cod.
L 260	SL2501--0000



Type 21

Barretta porta-blisters doppia.
Double hook blister-holder.
Doppelter Abhängearm für Blister-Packungen.
Tige porte-blisters double.
Двойной кронштейн для блистеров.

Dim. (mm)	Cod.
L 200	SL2101--0000
L 300	SL2102--0000



Type 26

Gancio universale.
Universal hook.
Universalhaken.
Crochet universal.
Универсальный крючок.

Dim. (mm)	Cod.
L 43	SL2601--0000



Type 22

Barretta a due gradini.
2-step hook.
2-Stufen Abhängearm.
Tige à deux marches.
2-х-ступенчатый крючок.

Dim. (mm)	Cod.
L 200	SL2201--0000



Type 27

Espositore a cremagliera.
Zig zag stand.
Zahnradlaufsteller.
Élément expositif à crémaillère.
Зигзаговый экспозитор.

Dim. (mm)	Cod.
L 300	SL2701--0000



Type 28

Barra inclinata.
Sloping arm.
Schräger Abhängearm.
Tige inclinée.
Наклонный кронштейн.

Dim. (mm)	Cod.
L 360	SL2801--0000



Type 33

Espositore porta cinture.
Belt display.
Aufsteller für Gürtel.
Porte-céintures.
Экспозитор для ремней.

Dim. (mm)	Cod.
L 300	SL3301--0000



Type 29

Porta pantaloni laterale.
Side trousers holder.
Seitiger Hosenträger.
Porte-pantalons latérale.
Боковой экспозитор для брюк.

Dim. (mm)	Cod.
L 360	SL2901--0000

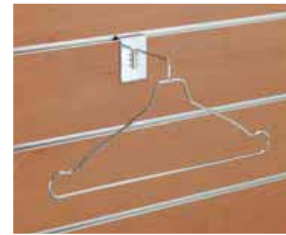

Type 34

Appendino.
Display hanger.
Kleiderbügel.
Cintre.
Плечики.

Dim. (mm)	Cod.
L 430	SL3401--0000



Type 30

Porta pantaloni frontale.
Frontal trousers holder.
Fronthosenträger.
Porte-pantalons frontale.
Фронтальный экспозитор для брюк.

Dim. (mm)	Cod.
L 400	SL3001--0000



Type 35

Porta scarpe.
Shoes display.
Aufsteller für Schuhe.
Porte-chaussures.
Полка для обуви.

Dim. (mm)	Cod.
L 290 x 290	SL3501--0000



Type 31

Braccio appenderia girevole.
Rotating hanging arm.
Drehbarer Abhängearm.
Bras d'accrochage tournant.
Кронштейн-карусель.

Dim. (mm)	Cod.
L 300	SL3101--0000
Ø 440	



Type 36

Espositore calzature singole.
Display for single shoe.
Aufsteller für Einzelschuh.
Elément pour une chaussure.
Одиночная подставка для обуви.

Dim. (mm)	Cod.
L 180	SL3601--0000



Type 32

Porta palloni.
Ball holder.
Ballträger.
Porte-ballons.
Подставка для мяча.

Dim. (mm)	Cod.
Ø 150	SL3201--0000



Type 37

Espositore porta camicie.
Shirt display.
Aufsteller für Hemden.
Etagère pour chemises.
Экспозитор для рубашек.

Dim. (mm)	Cod.
L 250 x 350	SL3701--0000



Type 38

Porta cappellini.
Millinery display.
Hütenträger.
Porte-chapeaux.
Экспозитор для головных уборов.

Dim. (mm)	Cod.
L 200 x 200	SL3801--0000



Type 39

Attacco per busto.
Fitting for bust.
Kupplung für Büste.
Attache pour buste.
Держатель торса.

Dim. (mm)	Cod.
L 175	SL3901--0000



Type 40

Supporto in lamiera per cassettera/armadietto.
Sheet support for drawer cabinet/cabinet.
Träger aus Blech für Schublade/Schrank.
Support en tôle pour tiroirs/armoire.
Металлический держатель ящика и шкафика.

Dim. (mm)	Cod.
L 38 x 85	SL4001--0000



Type 41

Supporto in lamiera per pesi leggeri.
Flat accessory bracket.
Träger aus Blech für leichte Lasten.
Support en tôle pour poids légers.
Металлический держатель для легких изделий.

Dim. (mm)	Cod.
L 38 x 45	SL4101--0000



Type 50

Pannello in MDF.
MDF panel.
MDF Paneel.
Panneau en MDF.
Панель MDF.

Dim. (mm)	Cod.
L 1200 x 1200 x 19 P 100	SL5001--0000



Type 50 terminale

Pannello in MDF terminale.
MDF panel with half end slat.
MDF Paneel mit Halbendlamelle.
Panneau en MDF avec demi rainure terminale.
Панель MDF Терминальная.

Dim. (mm)	Cod.
L 1200 x 1200 x 19 P 100	SL5001--00T0



Type 51

Pannello in MDF.
MDF panel.
MDF Paneel.
Panneau en MDF.
Панель MDF.

Dim. (mm)	Cod.
L 1200 x 1200 x 19 P 150	SL5101--0000



Type 51 terminale

Pannello in MDF terminale.
MDF panel with half end slat.
MDF Paneel mit Halbendlamelle.
Panneau en MDF avec demi rainure terminale.
Панель MDF Терминальная.

Dim. (mm)	Cod.
L 1200 x 1200 x 19 P 150	SL5101--00T0



Type 60

Coppia mensole trasparenti per ripiano.
Clear bracket pair for shelf.
Transparentes Trägerpaar für Fach.
Couple supports transparents pour étagère.
Пара прозрачных подержателей.

Dim. (mm)	Cod.
L 200	SL6001--0000
L 300	SL6002--0000
L 350	SL6003--0000



Type 65

Porta occhiali trasparente.
Clear spectacles support.
Transparentes Brillenträger.
Porte-lunettes transparent.
Прозрачная подставка для очков.

Dim. (mm)	Cod.
L 40	SL6501--0000



Type 61

Ripiano semicircolare trasparente.
Clear semi-circle shelf.
Transparentes Halbkreisförmigfach.
Étagère à demi-cercle transparente.
Полукруглая прозрачная полка для типа 3.

Dim. (mm)	Cod.
L 400 x 200	SL6101--0000



Type 66

Ripiano rettangolare trasparente.
Clear rectangular shelf.
Transparentes Rechteckfach.
Étagère rectangulaire transparente.
Прямоугольная прозрачная полка для типа 3.

Dim. (mm)	Cod.
L 305 x 150	SL6601--0000



Type 62

Ripiano rettangolare trasparente.
Clear rectangular shelf.
Transparentes Rechteckfach.
Étagère rectangulaire transparente.
Прямоугольная прозрачная полка для типа 3.

Dim. (mm)	Cod.
L 250 x 100	SL6201--0000



Type 67

Ripiano rettangolare trasparente.
Clear rectangular shelf.
Transparentes Rechteckfach.
Étagère rectangulaire transparente.
Прямоугольная прозрачная полка для типа 3.

Dim. (mm)	Cod.
L 370 x 150	SL6701--0000



Type 63

Barretta trasparente.
Clear face-out blister.
Transparentes Abhängearm.
Tige transparente.
Прозрачный кронштейн.

Dim. (mm)	Cod.
L 100	SL6301--0000
L 150	SL6302--0000



Type 68

Porta-prezzo trasparente per type 62-66-67-78.
Clear price-holder for type 62-66-67-78.
Transparentes Preisschildhalter für Typ 62-66-67-78.
Porte-prix transparent pour type 62-66-67-78.
Ценник прозрачный для типа 62-66-67-78.

Dim. (mm)	Cod.
L 120 x 35	SL6801--0000



Type 64

Gancio universale trasparente.
Clear multi-purpose hook.
Transparentes Universalhaken.
Crochet universel transparent.
Прозрачный универсальный крючок.

Dim. (mm)	Cod.
L 21	SL6401--0000



Type 69

Porta telefonino trasparente.
Clear mobile-holder.
Transparentes Handsträger.
Porte-portables transparent.
Прозрачная подставка для телефона.

Dim. (mm)	Cod.
L 77 x 188	SL6901--0000



Type 70

Porta scarpe orientabile trasparente.
Clear adjustable shoe-holder.
Transparentes richtbarer Schuhträger.
Porte-chaussures orientable transparente.
Регулируемая подставка для обуви.

Dim. (mm)	Cod.
L 76 x 251	SL7001--0000



Type 75

Piastra antiscivolo trasparente per type 73-77.
Anti-slip transparent plate for type 73-77.
Rutschfeste Platte transparent für Typ 73-77.
Plaque anti-glissance transparente pour type 73-77.
Противоскользящая прозрачная пластинка для типа 73-77.

Dim. (mm)	Cod.
L 180 x 365 x 2	SL7501--0000



Type 71

Profilo stondato terminale in alluminio.
Rounded end aluminium profile.
Abgerundetes Endprofil aus Aluminium.
Profil arrondi final en aluminium.
Закругленный терминальный алюминиевый профиль.

Dim. (mm)	Cod.
L 2400	SL7101--0000

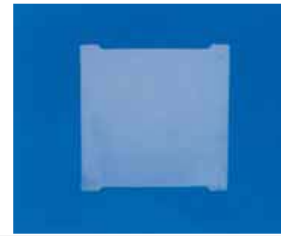

Type 76

Piastra antiscivolo trasparente per type 74.
Anti-slip transparent plate for type 74.
Rutschfeste Platte transparent für Typ 74.
Plaque anti-glissance transparente pour type 74.
Противоскользящая прозрачная пластинка для типа 74.

Dim. (mm)	Cod.
L 180 x 180 x 2	SL7601--0000



Type 72

Profilo stondato angolare in alluminio.
Rounded angular aluminium profile.
Abgerundetes Eckprofil aus Aluminium.
Profil arrondi angulaire en aluminium.
Закругленный угловой алюминиевый профиль.

Dim. (mm)	Cod.
L 2400	SL7201--0000



Type 77

Box porta calze trasparente.
Transparent tights-holder box.
Box Strumpfesträger transparent.
Boîte porte-bas transparente.
Прозрачный экспозитор колгот.

Dim. (mm)	Cod.
L 390 x 190 x h204	SL7701--0000



Type 73

Box porta calze trasparente.
Transparent tights-holder box.
Box Strumpfesträger transparent.
Boîte porte-bas transparente.
Прозрачный экспозитор колгот.

Dim. (mm)	Cod.
L 190 x 375 x h204	SL7301--0000



Type 78

Ripiano rettangolare trasparente.
Clear rectangular shelf.
Transparentes Rechteckfach.
Étagère rectangulaire transparente.
Прямоугольная прозрачная полка.

Dim. (mm)	Cod.
L 400 x 236	SL7801--0000



Type 74

Box porta calze trasparente.
Transparent tights-holder box.
Box Strumpfesträger transparent.
Boîte porte-bas transparente.
Прозрачный экспозитор колгот.

Dim. (mm)	Cod.
L 190 x 192 x h204	SL7401--0000



Type 79

Ripiano rettangolare inclinato trasparente.
Clear rectangular slanted shelf.
Transparentes Rechteckfach.
Étagère rectangulaire inclinée transparente.
Наклонная прямоугольная прозрачная полка.

Dim. (mm)	Cod.
L 175 x 293	SL7901--0000



Type 80

Ripiano in legno.
Wooden shelf.
Holzfach.
Étagère en bois.
Полка деревянная.

Dim. (mm)	Cod.
L 600 x 400 x 18	SL8001--0000
L 900 x 400 x 18	SL8002--0000
L 1200 x 400 x 18	SL8003--0000



Type 90

Colonna girevole su pedana.
Rotating column on platform.
Drehbare Säule auf Podest.
Colonne tournante sur estrade.
Вращающаяся колонна на подставке.

A: pannello/panel/paneel/panneau/панель
B: pedana/platform/podest/estrade/подставка

Dim. (mm)	Cod.
A: 400 x 1200 P 100	SL9001--0000
B: 700 x 700 x h 100	



Type 81

Ripiano in legno softformato.
Softforming wooden shelf.
Softforming Holzfach.
Étagère en bois softforming.
Полка деревянная с закругленным бортиком.

Dim. (mm)	Cod.
L 600 x 400 x 25	SL8101--0000
L 900 x 400 x 25	SL8102--0000
L 1200 x 400 x 25	SL8103--0000



Type 91

Gondola a doppia "T".
Double "T"-shaped gondola.
Doppel "T"-förmige Gondola.
Gondole à double "T".
Гондола формы двойной "Т".

A: pannello/panel/paneel/panneau/панель
C: base/base/hul/пед/основа

Dim. (mm)	Cod.
A: 600 x 1200 1200 x 1200 P 100	SL9101--0000
C: h 100	



Type 82

Ripiano in cristallo.
Crystal shelf.
Glasfach.
Étagère en cristal.
Полка стеклянная.

Dim. (mm)	Cod.
L 600 x 400 x 8	SL8201--0000
L 900 x 400 x 8	SL8202--0000
L 1200 x 400 x 8	SL8203--0000



Type 92

Gondola a doppia "T" con pedana.
Double "T"-shaped gondola with platform.
Doppel "T"-förmige Gondola mit Podest.
Gondole à double "T" avec estrade.
Гондола формы двойной "Т" на подставке.

A: pannello/panel/paneel/panneau/панель
B: pedana/platform/podest/estrade/подставка

Dim. (mm)	Cod.
A: 600 x 1200 1200 x 1200 P 100	SL9201--0000
B: 700 x 1340 x h 100	



Type 83

Ripiano in cristallo acidato.
Etched glass shelf.
Satiniertes Glasfach.
Étagère en cristal acidé.
Полка стеклянная сатирированная.

Dim. (mm)	Cod.
L 600 x 400 x 8	SL8301--0000
L 900 x 400 x 8	SL8302--0000
L 1200 x 400 x 8	SL8303--0000



Type 93

Gondola a croce.
Cross-shaped gondola.
Kreuzförmige Gondola.
Gondole à croix.
Гондола крестообразная.

A: pannello/panel/paneel/panneau/панель
C: base/base/hul/пед/основа

Dim. (mm)	Cod.
A: 600 x 1200 P 100	SL9301--0000
C: h 100	



Type 94

Gondola a croce con pedana.
Cross-shaped gondola with platform.
Kreuzförmige Gondola mit Podest.
Gondole à croix avec estrade.
Гондола крестообразная на подставке.

A: pannello/panel/paneel/panneau/панель
B: pedana/platform/podest/estrade/подставка

Dim. (mm)	Cod.
A: 600 x 1200 P 100	SL9401--0000
B: 1000 x 1000 x h 100	